

Technology that saves lives

Intelligent Fire Alarm Systems

VS1, VS4

FDNY
COA 6229

 7165-1657:
0244

Overview

Kidde brand intelligent life safety systems offer the power of high-end intelligent processing in configurations that deliver uncomplicated solutions for small to mid-sized applications. With intelligent detection, electronic addressing, automatic device mapping, optional Ethernet® connectivity, and a full line of easily-configured option cards and modules, these flexible systems offer versatility that benefits building owners and contractors alike.

The VS1 provides one Class A or Class B intelligent device loop that supports up to 64 device addresses, and two Class B Notification Appliance Circuits (NACs). Optional Class A device wiring is available with the use of a module.

The VS4 provides one Class A or Class B intelligent device loop that supports up to 250 device addresses. Loop controller modules may be added in combination to expand total system capacity in 250-point increments to up to 1,000 device addresses. VS4 panels include four NACs that may be wired for either Class A or Class B operation.

The RZ116-2 module adds even more capacity to VS installations by adding up to 16 conventional device circuits and two additional notification appliance circuits. This makes them ideal retrofit solutions that can accommodate new intelligent detectors, as well as existing conventional devices.

VS Series supports a wide range of high-end features, including:

- Intelligent modules, detectors, and bases
- GSA-REL Releasing Modules
- R-Series remote annunciators
- Integrated Carbon Monoxide gas sensing with V-PCOS detectors including distinct audible signaling

Features

- Auto-programming speeds installation time
- Supports V-Series intelligent modules and detectors
- Form C contacts for alarm and trouble, Form A for supervisory
- Electronic addressing with automatic device mapping
- Optional Ethernet port for diagnostics, programming and a variety of system reports
- Two programmable switches with LEDs and custom labeling
- Supports Genesis horn silence over two wires, and UL 1971-compliant strobe synchronization
- Supports GSA-REL releasing module for fire suppression
- Class B or Class A wiring
- Ground fault detection by module
- Supports up to eight serial annunciators, (LCD, LED-only, and graphic interface)
- Can use existing wiring for most retrofit applications
- Upload/download remotely or locally
- Two-level maintenance alert reporting
- Pre-alarm and alarm verification by point
- Adjustable detector sensitivity
- 4 x 20 character backlit LCD display
- Optional earthquake hardening: seismic Importance Factor 1.5
- Standalone operation
- Transmission test frequency by hour
- *Alarm ON* command manually activates alarm condition

Application

Kidde VS Series life safety systems are powerful intelligent solutions for small to mid-sized buildings. Advanced intelligent technology delivers the benefits of flexible system installation, while clean and easy-to-operate user interfaces make panel operation and system maintenance quick and intuitive.

The smart choice

Electronic addressing eliminates the tedium of setting dipswitches, and automatic device mapping ensures that each device resides on the system at its correct location. Meanwhile, innovative programming allows the designer to customize the system to precisely suit the needs of the building owner.

Reliability you can count on

The inherent fault-tolerant characteristics of Analog/Addressable Technology boosts the reliability of Kidde fire alarm systems. When combined with VS Series smoke and heat detectors, these systems deliver a level of dependability not previously available for small to mid-sized applications. All Kidde systems are built to exacting reliability benchmarks and meet international standards for quality, in addition to agency listings for dependability.

Clear-cut remote annunciation

Remote annunciation is a strong suit of the VS Series fire alarm systems. Up to eight annunciators can be installed on a single system. Compatible annunciators include a range of LED and LCD models that provide zone or point annunciation, as well as common control capabilities. VS control panels also supports graphic annunciation with optional graphic annunciator interface modules. Each interface provides common control and 32 LEDs.

Signals with a difference

VS Series NACs are configurable to fully support the advanced signaling technology of Kidde Genesis and Enhanced Integrity notification appliances. These devices offer precision synchronization

of strobes to UL 1971 standards. For Genesis devices, enabling this feature allows horns to be silenced while strobes on the same two-wire circuit continue to flash until the panel is reset.

Flexibility built right in

Two fully-programmable front panel switch/LED combinations provide an added measure of flexibility. Their slide-in labels take the mystery out of custom applications, and present a clean finished appearance.

Perfect for retrofits

Kidde VS Series control panels are particularly well-suited to retrofit applications. All connections are made over standard wiring – no shielded cable required. This means that in most situations existing wiring can be used to upgrade a legacy control panel to VS technology without the expense or disruption of rewiring the entire building. VS control panels also support the ingenious RZI16-2 zone module, which adds up to 16 conventional circuits and two NACs. This combination easily accommodates new intelligent detection alongside existing conventional circuits, making it an superior solution in the retrofit market.

Scalable IP and Cellular Communications

Several popular third-party IP/Cellular communicators have been tested with the VS control panels and are compatibility listed to UL864. The IP/Cellular communicators meet NFPA72 2013 edition requirements for sole or secondary transmission paths. Using IP/Cellular communicators can reduce the cost of ownership by eliminating POTS lines. Please see the VS control panel compatibility documentation part number 3102354-EN for a full list of compatible communicators.

A complete line of accessories

VS Series life safety systems are supported by a complete line of analog/addressable detectors, modules and related equipment. Consult the Ordering Information section for details.

Programming and remote diagnostics

Kidde VS Series life safety systems are simple to set up, yet offer advanced programming features that put these small building panels into a class of their own. The auto programming feature quickly gets the panel operational using factory default settings. Basic zone and point settings can be programmed through the front panel interface, so the system is up and running in no time.

For more advanced system configuration and correlation groups programming, VS Series systems interface to a PC running compatible VS-CU software. This option offers full system configuration in the familiar Windows® operating environment. Connection is made to a laptop through the panel's optional RS-232 communications port, which can also be used to connect a system printer.

Among the many innovative features of VS Series control panels is the optional network card. This module provides a standard 10/100 Base T Ethernet® network connection that permits access to the control panel from any remote location with the correct communications protocols. The connection can be used to download to the panel from the VS-CU, or upload and view system reports using the VS-CU.

Available system reports include: Correlation groups, Device details, Device maintenance, History, Internal status, System configuration, System status, Walk test, Dialer, and CO runtime.

Dimensions

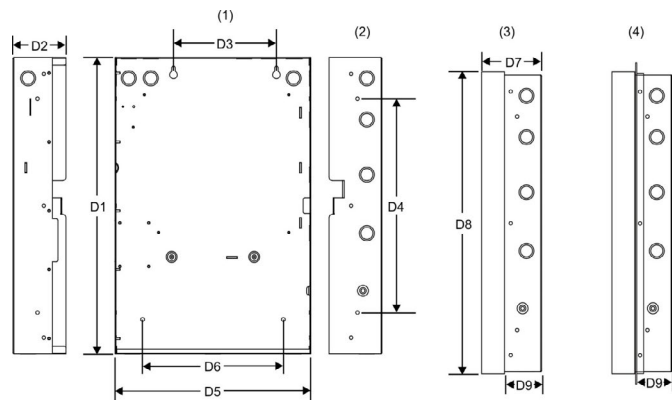

(1) Surface Mounting Holes

(2) Semi-flush mounting Holes

(3) Backbox with Door Attached

(4) Backbox with door and trim kit attached.

Panel dimensions, in (cm)

Model	D1*	D2	D3	D4	D5*	D6	D7	D8	D9
VS4	28.0 (71.1)	3.85 (9.8)	9.0 (22.8)	22.0 (55.8)	15.75 (40.0)	10.25 (26.0)	4.9 (12.4)	30.1 (76.4)	2.7 (6.8)
VS1	21.5 (54.6)	3.85 (9.8)	7.5 (19.0)	15.5 (39.4)	14.25 (36.2)	10.25 (26.0)	4.9 (12.4)	23.6 (59.9)	2.7 (6.8)

* Add 1-1/2 in. (3.81 cm) to D1 and D5 dimensions for trim kit. The trim kit provides 0.75 inches (1.9 cm) of trim to the top, bottom, and sides of the backbox.

System Layout

VS4

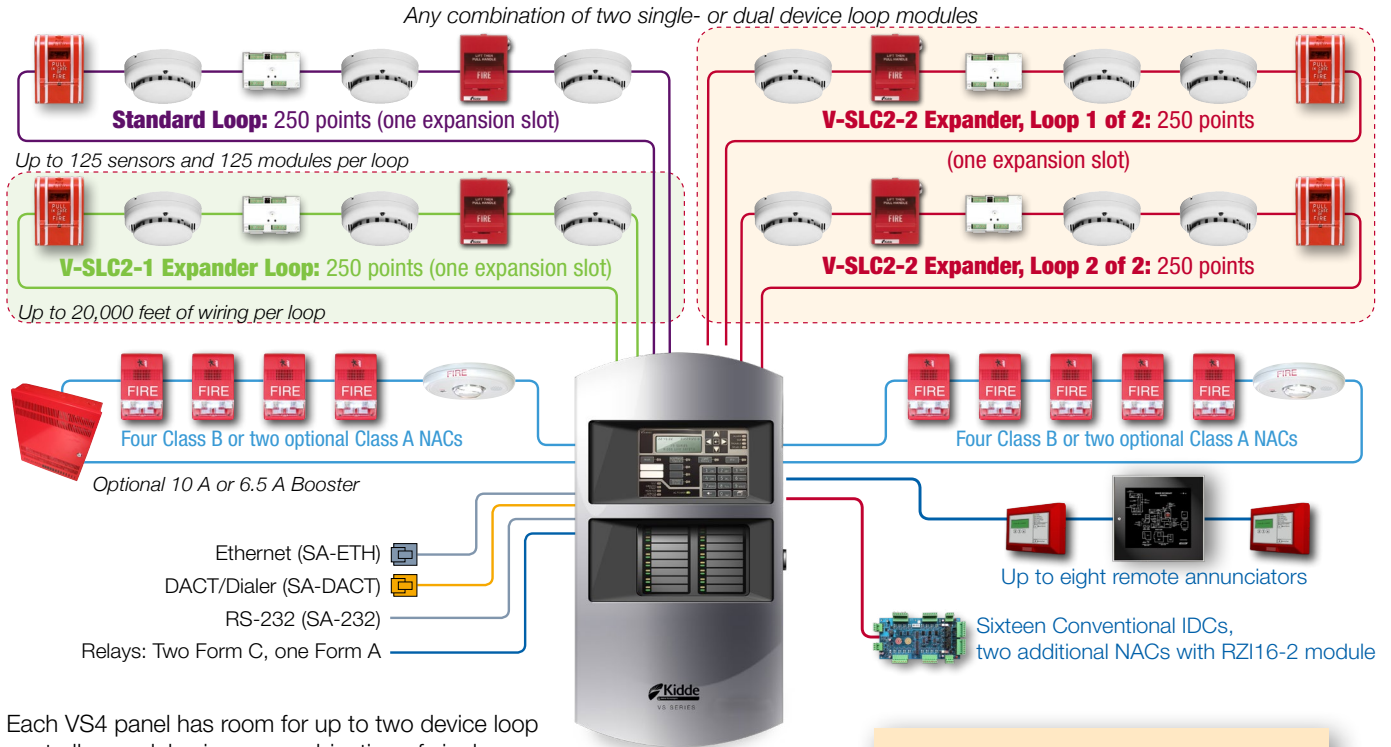

Each VS4 panel has room for up to two device loop controller modules in any combination of single or dual 250-device loops. VS4 comes with one loop that supports up to 125 detectors and 125 modules.

Panel Layout

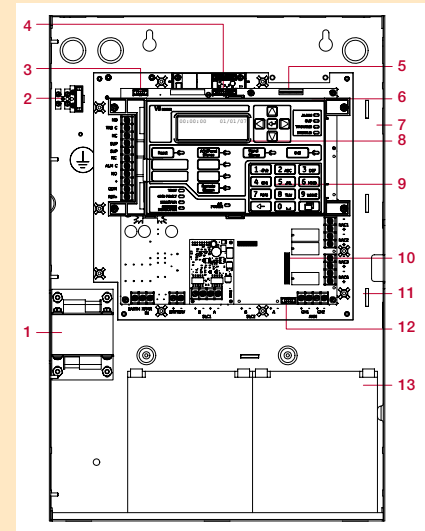

- 1 Transformer
- 2 Main AC wiring block & fuse holder
- 3 RS-232 card connector (J3)
- 4 Dialer card connection (J8)
- 5 Ethernet card connector (J1)
- 6 Main circuit board
- 7 Panel backbox enclosure
- 8 Operator interface
- 9 SLC card connector (J7)
- 10 Class A card connector (J2)
- 11 Tie wrap mounts
- 12 LED expander connector (J6)
- 13 Standby batteries

VS1

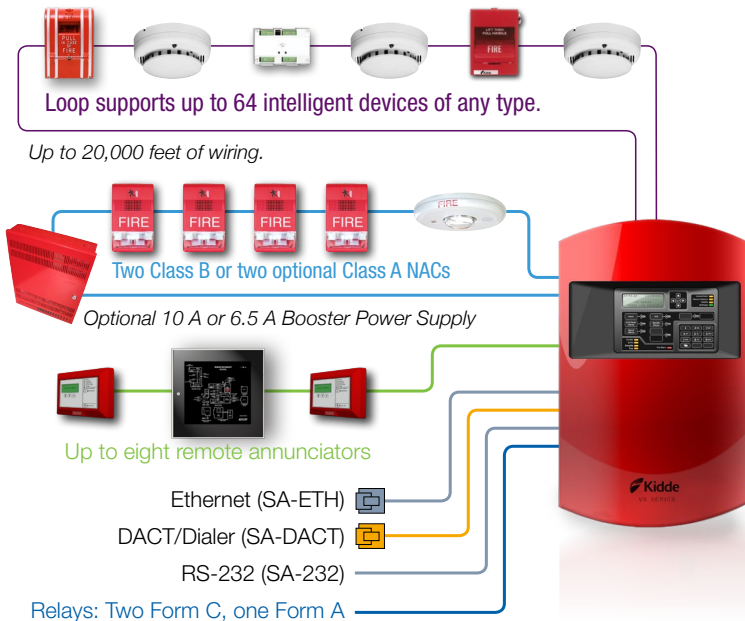

Each VS1 panel ships with one device loop controller that supports 64 devices of any type. This panel's device capacity cannot be expanded.

Wiring & Configuration

Device loop

The system provides one device loop circuit with a total capacity of 125 detectors and 125 module addresses. The loop circuit is supervised for opens, shorts, and grounds.

Circuit specifications	VS4	VS1
Device loops	One Class B or A loop, supporting 125 detectors and 125 modules. Expandable to four loops.	One Class B or A loop, supporting 64 devices of any kind.
Communication line voltage	Maximum 20 V peak-to-peak	
Circuit current	0.5 A max	
Circuit impedance	66Ω total, 0.5 μF, max	
Isolators	64 maximum	
Signal Synchronization	Supported on a system-wide basis (all device loops) when using an addressable notification appliance circuit (NAC) module and Genesis or Enhanced Integrity notification appliances.	

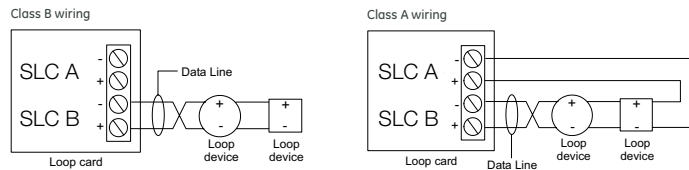

Notification appliance circuits (TB2)

VS4 control panels come equipped with four notification appliance circuits. VS1 control panels come with two NACs. Each circuit can be individually configured for continuous, temporal, synchronized, and coded output.

Specifications	VS4	VS1
Circuit Type	4 Class B or 2 Class A	2 Class B or 2 Class A with SA-CLA module
Voltage	24 VFWR	
Current	6.0 A total, 2.5 A max. per circuit at 120/230 VAC 60 Hz. 5.0 A total, 2.5 A max. per circuit at 230 VAC 50 Hz.	3.75 A total, 2.5 A max. per circuit at 120/230 VAC 60 Hz. 3.0 A total, 2.5 A max. per circuit at 230 VAC 50 Hz.
Impedance	26 Ω total, 0.35 μF max	
EOLR	15 K Ω, ½ W	
Synchronization	Supported system-wide	

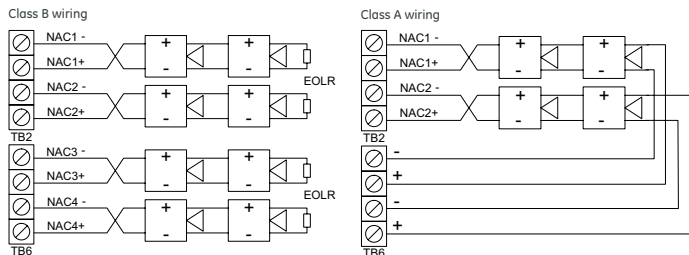

Marking indicates output signal polarity when the circuit is active. Polarity reverses when the circuit is not active. Wire notification appliances accordingly. Notification appliance polarity shown in active state.

Auxiliary & smoke power outputs (TB3)

The control panel provides two auxiliary power outputs that can be used for powering ancillary equipment such as remote annunciators and two wire smoke detectors. Aux 2 can be software selected to operate continuously. The circuit is supervised for shorts and grounds.

Circuit specifications

Circuit voltage range	21.9 to 28.3 V
Resettable circuit (Aux power 2)	24 VDC nominal at 500 mA
Continuous circuit (Aux power 1)	24 VDC nominal at 500 mA. Use this circuit for powering two-wire smoke detectors.

Note: Any current above 0.5 amp connected to both Aux 1 and 2 will reduce the total available NAC power by that amount.

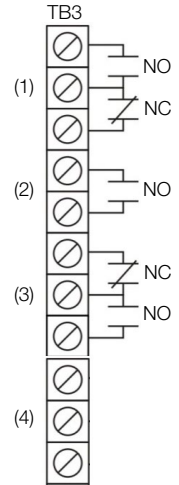

- (1) Trouble
- (2) Supervisory
- (3) Alarm
- (4) Smoke/Aux

Alarm, trouble, and supervisory relay (TB3)

The trouble relay is normally-open, held closed, and opens on any trouble event or when the panel is de-energized. The supervisory relay is normally-open, and closes on any supervisory event. The alarm relay changes over on any alarm event.

Relay specifications

	Alarm	Trouble	Supervisory
Type	Form C		
Voltage	24 VDC at 1 A resistive		

Relay circuits can only be connected to power-limited sources.

Annunciator loop (TB4)

The control panel provides a connection for up to eight serially driven and supervised remote annunciators.

Circuit specifications

Device loops	Class B (Style Y) or Class A (Style Z)
Circuit voltage	2.55 V
Circuit current	30 mA max
Circuit impedance	Up to 8 annunciators or 4000 feet

Class B

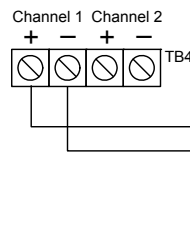

Class A

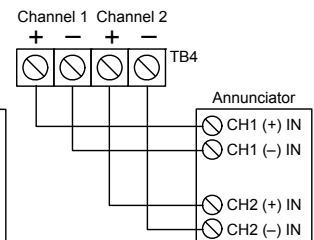

Option Cards

Kidde VS Series panels are supported by a complete line of modules and related equipment that enhance performance and extend system capabilities. Option cards plug directly into the control panel main circuit board or are connected to it with a ribbon cable. After installation, terminals remain accessible. The cabinet provides ample room for wire routing, keeping wiring neat at all times.

Single and Dual Loop Controller Cards

The V-SLC2-1 is a single loop controller card that can be used with the VS1 as a replacement for the standard 64-point loop, or with the VS4 as a 250-point expansion module.

The V-SLC2-2 is a 500-point dual loop controller card for the VS4 that provides two IDC circuits, each with 125 detector addresses and 125 module addresses.

Specifications	V-SLC2-1	V-SLC2-2
Device Addresses	VS4: one loop, 250 device addresses VS1: 64 addresses	VS4: two loops, 500 device addresses
Wiring	Class B or Class A	
Operating Voltage	24 VDC	
Operating Current (fully loaded loop)	Standby: 55 mA Alarm: 80 mA	Standby: 45 mA Alarm: 70 mA
<i>Note: These ratings do not include the use of two-wire smoke modules.</i>		
Communication Line Voltage	Max. 20.6 V peak-to-peak	
Terminal Rating	12 to 18 AWG (0.75 to 2.5 mm ²)	
Circuit Current	0.5 A max.	
Max total loop resistance	66 Ω	
Max total loop capacitance	0.5 μF	
Isolators	64 isolators maximum per loop (total both isolator bases and modules)	
Ground Fault Impedance	0 to 5 kΩ	
Operating Environment	32 to 120°F (0 to 49°C) 0 to 93% noncondensing at 90°F (32°C)	

SA-ETH Ethernet Interface Card

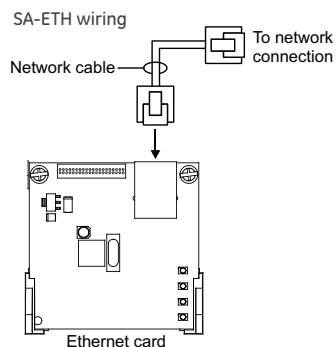

The SA-ETH card provides a standard 10/100 Base T Ethernet network connection for connecting to an intranet, a local network, or the Internet. The card can be used to download configuration programming from the VS-CU to the panel.

The Ethernet card is installed on the plastic assembly and connects to the main circuit board via a ribbon cable.

SA-ETH specifications

Ethernet	10/100 Base T
Operating environment	
Temperature	32 to 120°F (0 to 49°C)
Humidity	0 to 93% RH, noncondensing at 90°F (32°C)

RZI16-2 Remote Zone Interface Module

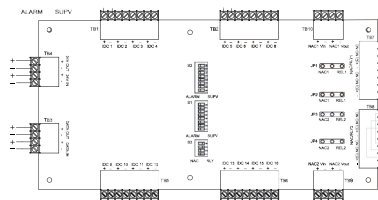

The RZI16-2 Addressable Remote Zone Interface Module is an addressable device that provides connections for sixteen Class B Initiating Device Circuits and two Class B Supervised Output Circuits. The inputs and outputs can be configured individually for several device types.

The RZI16-2 requires 18 consecutive addresses on the Signaling Line Circuit (SLC). Addresses are assigned electronically. There are no address switches to set.

The RZI16-2 incorporates two 8-segment DIP switches that are used to select the Alarm or Supervisory default device type for each of the 16 IDC circuits. The module also includes one 4-segment DIP switch used to select the default Relay or NAC output device type. Device types other than the default are accomplished through programming.

RZI16-2 Specifications

Voltage	
24V/Aux nominal:	24 VDC
Supervisory current:	250 mA at 24 VDC nominal
Alarm current:	1000 mA
24V/Aux minimum:	18.4 VDC
24V/Aux maximum:	26.4 VDC
NAC1, NAC2 nominal:	24 VDC
Current	
Standby current for 4.7 k EOL (U.S.)	4.8 mA/ circuit
Standby current for 3.9 k EOL (Canada)	5.7 mA/ circuit
Alarm current at nominal voltage	31.1 mA/ circuit
Relay outputs	
Quantity	2
Type Rating (pilot duty)	Programmable 24 VDC at 2.5 A
Input circuit wiring resistance	25 Ω per wire
Initiating device circuits	
Quantity	16
EOL resistor	4.7 kΩ (U.S.); 3.9 kΩ Canada
Zone voltage	22.78 V for 4.7 kΩ (U.S.) 22.08 V for 3.9 kΩ (Canada)
Alarm current	31.1 mA/ channel at nominal voltage
Alarm impedance range	< 680 Ω
Trouble impedance range	> 5.55 kΩ
Supervised output circuits	
EOL resistor	15 kΩ
Quantity	2
Short circuit detection	< 2.6 kΩ
Open circuit detection	> 61.9 kΩ
Contact ratings	24 VDC at 2.5 A (5 A for two NACs)
Compatible cabinets	MFC(A), VS4, APS

SA-DACT Dialer

The SA-DACT provides communications between the control panel and the central station over a telephone line system. It transmits system status changes (events) to a compatible digital alarm communicator receiver over the public switched telephone network. The dialer is capable of single, dual, or split reporting of events to two different account and telephone numbers. The modem feature of the SA-DACT can also be used for uploading and downloading panel configuration, history, and current status to a PC running the VS-CU.

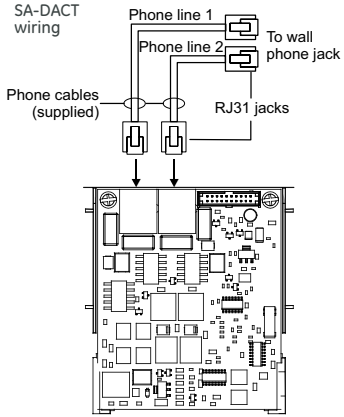

The dialer phone lines connect to connectors on the dialer's main circuit board. Phone line 1 connects to connector J4 and phone line 2 connects to connector J1.

The SA-DACT queues messages and transmits them based on priority (alarm, supervisory, trouble, and monitor). Activations are transmitted before restorations.

The SA-DACT is installed on the plastic assembly and connects to the main circuit board via a ribbon cable.

SA-DACT specifications	
Phone line type	One or two loop-start lines on a public, switched network
Phone line connector	RJ-31/38X (C31/38X)
Communication formats	Contact ID (SIA DC-05)
Operating environment	
Temperature	32 to 120°F (0 to 49°C)
Humidity	0 to 93% RH, noncondensing at 90°F (32°C)

Compatible DACRs		
Receiver	Models	Formats
Ademco	685	Contact ID
FBII	CP220	Contact ID
Osborne-Hoffman	OH 2000	Contact ID
Bosch	D6600	Contact ID
Silent Knight	9800	Contact ID
Sur-Gard	SG-MLR1, MLR2	Contact ID

SA-232 RS-232 interface

The SA-232 card provides an RS-232 interface with VS panels. It can be used for connecting a printer to the control panel to print system events. The card also can be used for connecting a computer to download a configuration program from the VS-CU to the control panel.

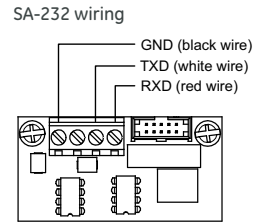

The RS-232 card is installed on the plastic assembly and connects to the main circuit board via a ribbon cable.

SA-232 specifications	
Operating voltage	Standard EIA-232
Terminal rating	12 to 18 AWG (0.75 to 2.5 sq mm)
Operating environment	
Temperature	32 to 120°F (0 to 49°C)
Humidity	0 to 93% RH, noncondensing at 90°F (32°C)

SA-CLA Class A Module (VS1 only)

The SA-CLA card provides Class A capability for NAC wiring. Its terminal block provides the wiring connection for NAC return wiring. The card is required for annunciator Class A wiring even though this wiring does not return to the SA-CLA card. The SA-CLA is compatible with VS1 control panels only. VS4 panels are Class A Ready. The SA-CLA is installed directly to the control panel circuit board using its plastic standoffs and plug connection.

SA-CLA specifications	
Operating voltage	24 VFWR
Operating current	3.75 A FWR total at 120/230 VAC 60 Hz 3.0 A FWR total at 230 VAC 50 Hz 2.5 A max per circuit
Circuit impedance	26 ohms, 0.35uF
Terminal rating	12 to 18 AWG (0.75 to 2.5 sq mm)
Operating environment	
Temperature	32 to 120°F (0 to 49°C)
Humidity	0 to 93% RH, noncondensing at 90°F (32°C)

D16L-VS LED Display Expander (VS4 only)

The D16L-VS LED Display Expanders provide LED annunciation for up to 16 zones. It provides two LEDs for each zone. Two D16L-VS LED display expanders can be installed in each VS4 panel.

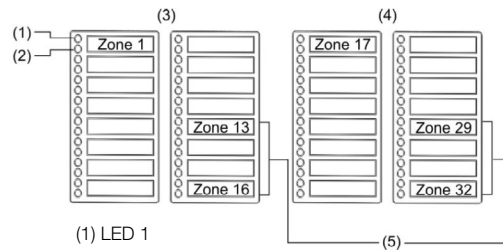

- (1) LED 1
- (2) LED 2
- (3) LED Expander 1
- (4) LED Expander 2
- (5) Alarm/non-alarm and trouble zone LEDs

Specifications

	VS1	VS4
Device loops	1 loop Class B or Class A (Styles 4, 6, 7) supporting up to 64 device addresses (any combination of detectors and modules) Maximum T-taps: 63 (each device can be on its own branch)	1 loop, expandable to 4, Class A or B (Styles 4, 6, 7), each loop supporting up to 250 device addresses (125 detectors and 125 modules max.). Addresses 1 to 125 are for detectors and addresses 126 to 250 are for modules Maximum T-taps/loop: 124
Notification appliance circuits	2 Class B (Style Y), Class A (Style Z) optional 3.75 A FWR total at 120/230 VAC 60 Hz 3.0 A FWR total at 230 VAC 50 Hz 2.5 A FWR each max. per circuit	4 Class B (Style Y) or 2 Class A (Style Z) 6.0 A FWR total at 120/230 VAC 60 Hz 5.0 A FWR total at 230 VAC 50 Hz 2.5 A FWR each max. per circuit
Primary power	120 VAC, 60 Hz, 1.3 A max. 230 VAC, 50-60 Hz, 0.62 A max.	120 VAC, 60 Hz, 2.0 A max. 230 VAC, 50-60 Hz, 0.97 A max.
Base panel current standby	155 mA	172 mA
Base panel current alarm	204 mA	267 mA
Input zones	16 max.	32 max.
Remote annunciator	8 drops max., RS-485 Class B, Class A is optional Data line length: 4,000 ft. (1,219 m)	8 drops max., RS-485 Class A or B Data line length: 4,000 ft. (1,219 m)
Operating voltage	24 VDC panel	
Auxiliary power output circuit	Aux power 1: 500 mA, 24 VDC Aux power 2: 500 mA, 24 VDC (1 A possible if you reduce total available NAC power by 500 mA) Output: 28.3 to 21.9 VDC, special application <i>Note: For a list of compatible devices, see the VS1 and VS4 Series Compatibility List (P/N 3102354-EN)</i>	
Loop circuit	Maximum loop resistance: 66 Ω Maximum loop capacitance: 0.5 μ F Communication line voltage: Maximum 20.6 V peak-to-peak Operating current (fully loaded loop) Stand by: 55 mA/45 mA Alarm: 125 mA/115 mA (not including two-wire smoke modules) Circuit current: 0.5 A max. Style 4, 6, and 7 wiring Max. resistance between isolators: Limited only by overall wire run lengths 64 isolators maximum per loop (total both isolator bases and modules)	
Batteries	Type: Sealed lead acid Voltage: 24 VDC Charging current: 2.47 A max. Amp hour capacity: 26 Ah Standby operation: 24 hour or 60 hour Placement: Up to two 10 Ah batteries will fit in the VS1 control panel cabinet and two 18 Ah batteries will fit in the VS4 control panel cabinet. If larger batteries are required, use a battery cabinet.	
SA-DACT dialer	Phone line type: One or two loop-start lines on a public, switched network Phone line connector: RJ-31/38X (C31/38X) Communication formats: Contact ID (SIA DC-05) Operating current Standby/Alarm: 41 mA Max.: 100 mA FCC registration number: GESAL01BSADACT Industry Canada Registration number: 3944A-SADACT Ringer equivalence number: 0.1B	
Ground fault impedance	0 to 5 k Ω	
Alarm contact	Form C N.O. 24 VDC at 1 A (resistive load)	
Trouble contact	Form C 24 VDC at 1 A (resistive load)	
Supervisory contact	Form A N.O. 24 VDC at 1 A (resistive load)	
Environmental	Temperature: 0 to 49°C (32 to 120°F) Relative humidity: 0 to 93% noncondensing	
Terminal rating	All terminals rated for 12 to 18 AWG (0.75 to 2.5 mm ²)	



Technology that saves lives

Contact us

Phone: 888.244.9979 (Option 4)
 Email: kidde.fire@carrier.com
 Website: kidde-esfire.com

Kidde is a Carrier brand.
 8985 Town Center Pkwy,
 Bradenton, FL 34202

© 2020 Carrier
 All rights reserved.

Ordering Information

Part	Description
------	-------------

VS4 Fire Alarm Systems

VS4-G	Four loop system with one 250-point loop installed. 110v, gray door.
VS4-G-2	Four loop system with one 250-point loop installed. 230v, gray door.
VS4-G-2-PG	Four loop system with one 250-point loop installed. 230v, gray door, Portuguese.
VS4-G-2-SP	Four loop system with one 250-point loop installed. 230v, gray door, Spanish.
VS4-GC	Four loop system, one 250-point loop installed. 110v, gray door, LED strips, Canada.
VS4-GD	Four loop system, one 250-point loop installed. 110v, gray door, with dialer.
VS4-GF	Four loop system, one 250-point loop. 110v, gray door, LED strips, French Canada.
VS4-G-PG	Four loop system with one 250-point loop installed. 110v, gray door, Portuguese.
VS4-G-SP	Four loop system with one 250-point loop installed. 110v, gray door, Spanish.
VS4-R	Four loop system with one 250-point loop installed. 110v, red door.
VS4-R-2	Four loop system with one 250-point loop installed. 230v, red door.
VS4-RD	Four loop system, one 250-point loop installed. 110v, red door, with dialer.
SA-TRIM2	VS4 Flush mount trim, black.

VS1 Fire Alarm Systems

VS1-G	One loop system with one 64-point loop installed. 110v, gray door.
VS1-G-2	One loop system with one 64-point loop installed. 230v, gray door.
VS1-G-2-PG	One loop system with one 64-point loop installed. 230v, gray door, Portuguese.
VS1-G-2-SP	One loop system with one 64-point loop installed. 230v, gray door, Spanish.
VS1-GD	One loop system, one 64-point loop installed. 110v, gray door, with dialer.
VS1-GL	One loop system, one 64-point loop installed. 110v, gray door, English Canada.
VS1-GL-F	One loop system, one 64-point loop installed. 110v, gray door, French Canada.
VS1-G-PG	One loop system with one 64-point loop installed. 110v, gray door, Portuguese.
VS1-G-SP	One loop system with one 64-point loop installed. 110v, gray door, Spanish.
VS1-R	One loop system with one 64-point loop installed. 110v, red door.
VS1-R-2	One loop system with one 64-point loop installed. 230v, red door.
VS1-RD	One loop system, one 64-point loop installed. 110v, red door, with dialer.
SA-TRIM1	VS1 Flush mount trim, black

Option Cards

V-SLC2-1	Expansion module, one 250-device loop. For VS4 only.
V-SLC2-2	Expansion module, two 250-device loops, 500 devices total. For VS4 only.
RZI16-2	Remote Zone Interface Module. 16 Class B IDCs, 2 Class B Output. Bracket included.
SA-DACT	Dual Line Dialer/Modem, supports Contact ID, mounts in cabinet on base plate.
SA-232	RS-232 Serial Port for connection to printers & computers, mounts in cabinet.
SA-ETH	Ethernet Port, Slave, mounts in cabinet on base plate.
SA-CLA	Class A adapter module. Provides Class A capacity on NACs. Mounts in cabinet on main board. VS1 systems only.
D16L-VS	LED Annunciator module, 16 X 2-LED zones (4 programmable for sup). Mounts in cabinet to right of LCD display. For VS4 only.
D8RY-VS	Canada only: LED Annunciator module, two LEDs per zone, 16 zones (4 alarm only, 8 supervisory only, 4 alarm or supervisory). Mounts in cabinet. For VS4 only.

Accessories

CTM	City Tie Module. 2-gang. Connection to a local energy fire alarm box.
MFC-A	Multifunction Fire Cabinet, 8" x 14" x 3.5" - red.
BC-1	Battery Cabinet. 14.0" x 18.25" x 7.25". Holds two 12V24A batteries.
BC-1R	Battery Cabinet - Red. 14.0" x 18.25" x 7.25". Holds two 12V24A batteries.
GSA-REL	Releasing Module
BC-1EQ	Seismic hardening Kit for VS Series panels. Includes battery hardening for BC-1 enclosure and components to harden panel internal components.

Programming Tools

VS-CU	VS Series configuration and diagnostics utility.
260097	RS232 cable, 4 conductor, DB9 PC interface